

# PRINTER Controller Type 1055

## OPERATING INSTRUCTIONS PRINTER REFERENCE 1 (option)



- 
- 1 Getting Started
  - 2 Configuring the Printer for the Network
  - 3 Installing the Printer Driver and Software

## **Introduction**

This manual contains detailed instructions on the operation and maintenance of this machine. To get maximum versatility from this machine all operators should carefully read and follow the instructions in this manual.

Please keep this manual in a handy place near the machine.

Please read the Safety Information in the "Copy Reference" before using this machine. It contains important information related to USER SAFETY and PREVENTING EQUIPMENT PROBLEMS.

## **Important**

Contents of this manual are subject to change without prior notice. In no event will the company be liable for direct, indirect, special, incidental, or consequential damages as a result of handling or operating the machine.

## **Trademarks**

Microsoft® and Windows® are registered trademarks of Microsoft Corporation in the United States and/or other countries.

Ethernet® is a registered trademark of Xerox Corporation.

PostScript® and Acrobat® are registered trademarks of Adobe System Incorporated.

PCL® is a registered trademark of Hewlett-Packard Company.

Other product names used herein are for identification purposes only and might be trademarks of their respective companies. We disclaim any and all rights in those marks.

IPS-PRINT™ Printer Language Emulation Copyright® 2000, Oak Technology, Inc., All Rights Reserved.

## **Warning:**

Use of controls or adjustment or performance of procedures other than those specified in this manual might result in hazardous radiation exposure.

## **Notes:**

Some illustrations in this manual might be slightly different from the machine.

Certain options might not be available in some countries. For details, please contact your local dealer.

# TABLE OF CONTENTS

<b>Manuals for This Machine .....</b>	<b>1</b>
Manuals for This Machine .....	1
<b>How to Read This Manual .....</b>	<b>2</b>
<b>1. Getting Started</b>	
<hr/>	
<b>Connecting the Machine .....</b>	<b>3</b>
Requirements .....	3
Connecting the Machine Using Network Interface Board Type 450-E .....	5
Connecting the Machine to the Host Using the Parallel Interface Cable .....	6
<b>Features of this Machine .....</b>	<b>7</b>
Printer Drivers for This Machine .....	8
Software and Utilities Included on the CD-ROM .....	9
<b>Guide to This Machine .....</b>	<b>10</b>
Control Panel .....	10
Display Panel .....	11
<b>2. Configuring the Printer for the Network</b>	
<hr/>	
<b>Configuring the Printer for the Network with the Control Panel .....</b>	<b>13</b>
Protecting the Network Menu .....	14
<b>3. Installing the Printer Driver and Software</b>	
<hr/>	
<b>Installation Method .....</b>	<b>17</b>
<b>Quick Install .....</b>	<b>18</b>
<b>Installing the PCL 6/5e Printer Driver .....</b>	<b>20</b>
Installing the PCL 6/5e Printer Driver .....	20
<b>Installing the PostScript 3 Printer Driver .....</b>	<b>22</b>
Windows 95/98/Me - Installing the PostScript 3 Printer Driver .....	22
Windows 2000/XP - Installing the PostScript 3 Printer Driver .....	24
Windows NT 4.0 - Installing the PostScript 3 Printer Driver .....	26
Mac OS - Installing the PostScript 3 Printer Driver and Utilities .....	28
Mac OS X - Installing the PostScript 3 Printer Driver .....	30
<b>Installing the SmartNetMonitor for Client / Admin .....</b>	<b>31</b>
<b>Installing the Agfa Monotype Font Manager 2000 .....</b>	<b>32</b>
<b>Using Adobe PageMaker Version 6.0, 6.5 or 7.0 .....</b>	<b>33</b>
<b>INDEX .....</b>	<b>34</b>



# Manuals for This Machine

---

## Manuals for This Machine

---

There are seven manuals that separately describe the operational procedures for the operation and maintenance of the machine.

To enhance safe and efficient operation of the machine, all users should read and follow the instructions contained in the following manuals.

### ❖ **Copy Reference**

Describes the procedures and functions for using this machine as a copier.

### ❖ **System Settings**

Describes the system settings of this machine.

### ❖ **Printer Reference 1**

Describes the system settings, procedures and functions for using this machine as a printer. (This Manual)

### ❖ **Printer Reference 2**

Describes the procedures and provides necessary information about using this machine as a printer. The manual is included as a PDF file on the CD-ROM labeled "Printer Drivers and Utilities".

### ❖ **Network Interface Board Quick Configuration Guide**

Describes the procedures and provides necessary information about setting up and using the printer under the network environment. We recommend this manual as your first choice. The manual is included as a PDF file on the CD-ROM labeled "Printer Drivers and Utilities". Read this manual as your first choice before referring to the paper version of the Quick Configuration Guide which comes with optional Network Interface Board Type 450-E.

### ❖ **PostScript 3 Operating Instructions Supplement**

Describes the menus and features you can set using the PostScript printer driver. The manual is provided as a PDF file on the CD-ROM labeled "Printer Drivers and Utilities".

### ❖ **Network Interface Board Type 450-E Owner's Manual**

Describes the procedures and provides necessary information about setting up and using the printer under the network environment. The manual is provided as a PDF file which is included on the CD-ROM labeled "Print Server Software and Documentation" which comes with optional Network Interface Board Type 450-E.

# How to Read This Manual

---

## Symbols

---

In this manual, the following symbols are used:

### **WARNING:**

This symbol indicates a potentially hazardous situation which, if instructions are not followed, could result in death or serious injury.

### **CAUTION:**

This symbol indicates a potentially hazardous situation which, if instructions are not followed, may result in minor or moderate injury or damage to property.

\* The statements above are notes for your safety.

### **Important**

If this instruction is not followed, paper might be misfed, originals might be damaged, or data might be lost. Be sure to read this.

### **Preparation**

This symbol indicates the prior knowledge or preparations required before operating.

### **Note**

This symbol indicates precautions for operation, or actions to take after misoperation.

### **Limitation**

This symbol indicates numerical limits, functions that cannot be used together, or conditions in which a particular function cannot be used.

### **Reference**

This symbol indicates a reference.

[    ]

Keys that appear on the machine's display panel.

Keys and buttons that appear on the computer's display.

【    】

Keys built into the machine's control panel.

Keys on the computer's keyboard.

# 1. Getting Started

## Connecting the Machine

Confirm that the shape and the position of the connector are as shown in the illustration.

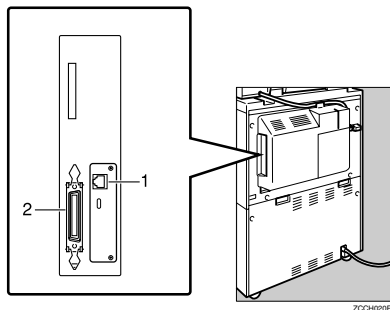

1. 10BASE-T/100BASE-TX (option)

2. Parallel Port

---

### Requirements

---

---

### Requirements

---

Before using this machine, confirm that all the environmental and electrical requirements have been met. Connect the machine to the host computer using the parallel port, optional Network Interface Board Type 450-E, or both.

Confirm that all the cables, connectors, and electrical outlets necessary to attach the machine to the host computer or network are present.

### Important

The interface cable is not supplied in the box. It is your responsibility to provide the interface cable appropriate for the computer that you are using.

### Reference

For more information about using the parallel port, see p.6 "Connecting the Machine to the Host Using the Parallel Interface Cable".

For more information about using a network, see p.4 "Network cable requirements".

---

## Network cable requirements

---

Optional Network Interface Board Type 450-E can be installed to allow direct connection to an Ethernet network.

Network Interface Board supports 10BASE-T or 100BASE-TX connections.

You can use the machine in the following network environments:

- Using the appropriate network management software and printer driver.
- Attaching the machine to a networked computer set up as a server.

<b>Client</b>	Windows 95/98/Me, Windows 2000/XP, Windows NT 4.0, <sup>*1</sup> , Mac OS (optional PostScript 3 Kit Type 700 is required )
<b>Driver</b>	PCL 6/5e, PostScript 3
<b>File Server</b>	NetWare 3.x, NetWare 4.x, NetWare 5.x
<b>Protocol</b>	TCP/IP, IPX/SPX, AppleTalk

<sup>\*1</sup> Under Windows NT 4.0, only x86 CPU is supported.

In a mixed network environment, the protocol switches automatically.

### Reference

For more information about resolving network connection problems, see p.13 “Configuring the Printer for the Network”.

### Note

- Consult your network administrator before connecting the machine to a network.
- Be sure to use properly shielded and grounded cable (STP, Category/Type5) for the connection to the host computer (and/or HUB) in order to meet FCC and EMC Directive 89/336/EEC emission guidelines.

---

## Parallel cable requirements

---

Connect the machine to the host computer using a parallel port. This machine does not provide the parallel cable to connect the machine to the host computer.

The machine's parallel interface is a standard bi-directional interface. It requires a standard 36-pin parallel cable compliant with IEEE 1284 and a parallel port available on the host computer.

### Note

- Do not use a parallel cable that is longer than 3 meters (10 feet).



## Connecting the Machine Using Network Interface Board Type 450-E

Connect the machine to the network using Network Interface Board Type 450-E. Follow these steps to connect the machine.

- 1** Confirm that you have the correct cable.
- 2** Confirm that the machine is turned off.
- 3** Loop the network cable. The loop should be about 15cm (6") from the end of the cable on the end closest to the printer.
- 4** Attach the ferrite core to the loop.

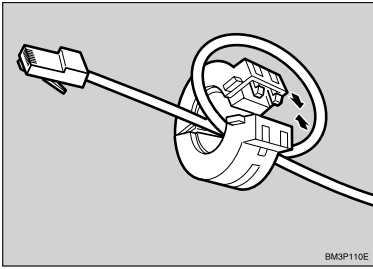

- 5** Attach the network cable to the 10BASE-T/100BASE-TX port on the machine.

### Reference

See p.3 "Connecting the Machine" to confirm of the position of the 10BASE-T/100BASE-TX port.

### Note

- Confirm that the cable is connected to the 10BASE-T/100BASE-TX port.

- 6** Connect the other end of the cable into the network.

---

## Indicators on Network Interface Board

---

1

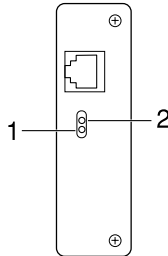

### 1. Indicator (orange)

Is on while Network Interface Board is working.

### 2. Indicator (green)

Is on while the machine is in a network environment.

---

## Connecting the Machine to the Host Using the Parallel Interface Cable

---

Connect the machine to the host computer using a parallel interface cable compliant with IEEE 1284 (supplied by you).

Follow these steps to connect the machine to the host computer.

- 1** Confirm that you have the correct cable.
- 2** Confirm that both the machine and the host computer are turned off.
- 3** Plug the 36-pin end of the parallel cable into the parallel port at the right side of the back cover of the machine.

### Reference

See p.3 “Connecting the Machine” to confirm the position of the parallel port.

- 4** Squeeze the wire clips on each side of the connector together until they snap into place. The clips hold the cable securely in place.
- 5** Plug the other end of the parallel cable into the computer's parallel port.

# Features of this Machine

This machine is designed for office workgroups and CRD, both for shared usage within network environment, and for one-to-one usage by being connected directly to the computer.

## ◆ High Productivity

This machine comes with an 55-page per minute (ppm) engine and offers a variety of paper handling functions. A Document Server function enables you to save documents in the machine memory and then edit and print them as you want. Sample print allows you to confirm the printing documents as expected before printing many.

## ◆ Versatile Paper Handling Options

This machine offers both versatile input and output paper handling options. Input capacity can be raised to 7,750 sheets with the optional Large Capacity Tray. For an output device, punching is available with the optional finisher.

## 🔍 Reference

For more information about supporting paper size and type, and optional input and output devices, see the “Copy Reference” manual.

## ◆ Variety of Paper Media Support with Easy Handling

Paper types can be selected from the printer driver. If you set the paper type for each tray in advance, you can only select the paper type from the printer driver.

## ◆ Network Connectivity

This machine is network ready with optional Network Interface Board.

## ◆ Network Utility

SmartNetMonitor<sup>\*1</sup>, software consisting of Administrator and Client versions, is provided. With this software, multiple print devices can be utilized effectively together on a network. This software offers several convenient functions such as parallel printing and recovery printing.

<sup>\*1</sup> For the name of SmartNetMonitor you use, see the “Quick Configuration Guide” for optional Network Interface Board which is included as a PDF file on the CD-ROM labeled “Printer Drivers and Utilities”.

## ◆ Major Specifications

Printing Speed	55ppm (A4☐, 8 <sup>1</sup> / <sub>2</sub> " × 11"☐)
Engine Resolution	600dpi resolution
Printer Language	PCL 5e, PCL 6 Adobe PostScript Level 3 <sup>*1</sup>
Memory	32MB Max. up to 160MB
Interface	10BASE-T or 100BASE-TX <sup>*1</sup> × 1 IEEE1284 × 1

<sup>\*1</sup> Option

## Printer Drivers for This Machine

Printing requires installation of a printer driver for your operating system. The following drivers are included on the CD-ROM that comes with this machine.

Operating system	Printer Language	PCL 6	PCL 5e	PostScript 3
Windows 95 <sup>*1</sup>		√	√	√ <sup>*11</sup>
Windows 98 <sup>*2</sup>		√	√	√ <sup>*11</sup>
Windows Me <sup>*3</sup>		√	√	√ <sup>*11</sup>
Windows 2000 <sup>*4</sup>		√	√	√ <sup>*12</sup>
Windows XP <sup>*5</sup>		√	√	√ <sup>*12</sup>
Windows NT 4.0 <sup>*6</sup>		√ <sup>*9</sup>	√ <sup>*9</sup>	√ <sup>*10</sup> <sup>*11</sup>
Mac OS <sup>*7</sup>				√ <sup>*11</sup>
Mac OS X <sup>*8</sup>				√ <sup>*13</sup>

<sup>\*1</sup> Microsoft Windows 95 operating system

<sup>\*2</sup> Microsoft Windows 98 operating system

<sup>\*3</sup> Microsoft Windows Millennium Edition

<sup>\*4</sup> Microsoft Windows 2000 Advanced Server

Microsoft Windows 2000 Server

Microsoft Windows 2000 Professional

<sup>\*5</sup> Microsoft Windows XP Professional

Microsoft Windows XP Home Edition

<sup>\*6</sup> Microsoft Windows NT Server operating system version 4.0, Microsoft Windows NT Workstation operating system version 4.0 in a computer using x86 processors.

<sup>\*7</sup> Versions 8.6 to 9.2 of the Mac OS (Mac OS X Classic mode is supported.)

<sup>\*8</sup> Mac OS X 10.1 or later (Native mode)

<sup>\*9</sup> Requires Service Pack 4 or later.

<sup>\*10</sup> Requires Service Pack 6 or later.

<sup>\*11</sup> The Adobe PostScript 3 printer drivers and PostScript Printer Description (PPD) files are included on the CD-ROM labeled "Printer Drivers and Utilities".

<sup>\*12</sup> The PostScript Printer Description (PPD) files are included on the CD-ROM labeled "Printer Drivers and Utilities".

<sup>\*13</sup> The Adobe PostScript Printer Description (PPD) installer is included on the CD-ROM labeled "Printer Drivers and Utilities".

### ◆ PCL Printer Drivers

Printer drivers allow the computer to communicate with the machine via a printer language. Two kinds of PCL printer drivers, PCL 6 and PCL 5e, are included on the CD-ROM that comes with this machine. We recommend PCL 6 as your first choice. However, some of your applications might require the installation of the PCL 5e printer driver. In this case, you can install PCL 5e in addition to PCL 6.

⇒ p.20 "Installing the PCL 6/5e Printer Driver"

### ❖ Adobe PostScript 3 Printer Drivers and PPD files

The Adobe PostScript 3 printer drivers and the PPD files are included on the CD-ROM that comes with this machine. Adobe PostScript 3 printer driver allows the computer to communicate with the machine via a printer language. The PPD files allow the printer driver to enable the printer specific functions.

- ⇒ p.22 “Windows 95/98/Me - Installing the PostScript 3 Printer Driver”
- ⇒ p.24 “Windows 2000/XP - Installing the PostScript 3 Printer Driver”
- ⇒ p.26 “Windows NT 4.0 - Installing the PostScript 3 Printer Driver”
- ⇒ p.28 “Mac OS - Installing the PostScript 3 Printer Driver and Utilities”
- ⇒ p.30 “Mac OS X - Installing the PostScript 3 Printer Driver”

---

## Software and Utilities Included on the CD-ROM

---

### ❖ Afga Font Manager

Helps you to install new screen fonts, or organize and manage fonts already installed on your system.

#### Important

- If you upgrade to Windows 2000, Afga Font Manager must be uninstalled prior to install Windows 2000. And then reinstall it in a Windows 2000 environment.

### ❖ SNM-Admin

A utility for the system administrator to manage printers on the network.

#### Reference

For the name of SNM-Admin you use, see the “Quick Configuration Guide” for optional Network Interface Board which is included on the CD-ROM labeled “Printer Drivers and Utilities”.

See SNM-Admin Online Help for more information about using SNM-Admin.

### ❖ SNM-Client

A utility for users to manage their own print jobs on the network.

#### Reference

For the name of SNM-Client you use, see the “Quick Configuration Guide” for optional Network Interface Board which is included on the CD-ROM labeled “Printer Drivers and Utilities”.

See SNM-Client Online Help for more information about using SNM-Client.

### ❖ Acrobat Reader

A utility that allows you to read PDF (Portable Document Format).

#### Note

- Documentation about using the printer is included on the CD-ROM in PDF format.

# Guide to This Machine

## 1

### Control Panel

This display panel is for the installed Copier and Printer.

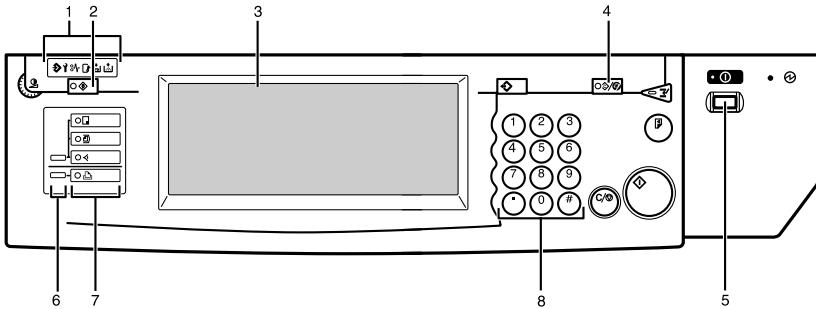

20000000

#### 1. Shows errors and machine status.

↔: Data In indicator

The Data In indicator shows the status of data reception from a computer.

- This indicator blinks when data is being received.
- This indicator goes on when there is data remaining to be printed.

⚠: Service call indicator

⚠: Misfeed indicator

⚠: Cover indicator

⚠: Staple indicator

⚠: Toner indicator

#### 2. 【User Tools/Counter】 key

- User Tools  
Press to change the default settings and conditions to meet your requirements.
- Counter  
Press to check or print the total number of copies made.

#### 3. Display panel

Shows operation status, error messages, and function menus.

#### 4. 【Clear Modes/Energy Saver】 key

- Clear Modes  
Press to clear any previously entered copy job settings.
- Energy Saver  
Press to switch to and from Energy Saver mode.

#### 5. Operation switch

Press this switch to turn the power on (the On indicator goes on). To turn the power off, press this switch again (the On indicator goes off).

#### 6. Function Status indicators

These show the status of the functions below:

- Green: the function is active.
- Red: the function has been interrupted.

#### 7. Function keys

Press the appropriate key to choose any of the following functions:

- Copy
- Document Server New Job
- Job List
- Printer

## 8. Number keys

Use to enter the desired number of copies and data for selected modes.

## Display Panel

The display shows the status of the machine, error messages and function menus. To select items shown on the display, lightly press the items with your finger. When the item is selected, it is highlighted. Items that are not available are shown grayed out.

### Important

- Do not apply a strong shock or force of more than about 30 N<sup>\*1</sup> (about 3 kgf<sup>\*2</sup>) to the display panel or it may be damaged.

\*1 N = Newton

\*2 kgf = Kilogram force (1 kgf ≅ 9.8 N)

## Online and Offline

Press the **[Printer]** key on the control panel.

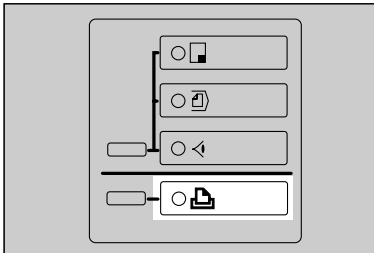

ZCCS090E

The following screen appears on the display panel.

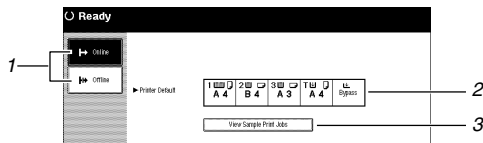

### 1. Online/Offline

Shows the status of “Online” or “Offline”.

### 2. Printer Default

Shows the default input tray and paper size which is selected on the display. However, if “Auto” is selected in “Tray Priority”, no tray is highlighted.

### 3. View Sample Print Jobs

Press to show the list of “Sample Print Jobs”. You can also select each file to print, to delete, to save and to change settings.

---

## Online

---

When the machine is online, it can receive data from the computer.

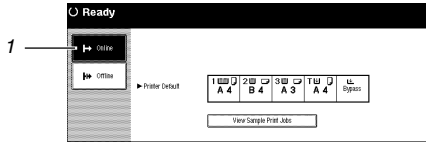

### 1. [Online] key

Press this key to switch the machine on-line. The preceding illustration shows the online status.

---

## Offline

---

When the machine is offline, it cannot receive data from the computer.



### 1. [Offline] key

Press this key to switch the printer off-line. The preceding illustration shows the offline status.

### 2. [Job Reset] key

Press this key to cancel the current print job.



# 2. Configuring the Printer for the Network

## Configuring the Printer for the Network with the Control Panel

After installing optional Network Interface Board, configure it for the network using the machine's control panel.

If you use TCP/IP, you should assign the IP Address and Subnet Mask. You can also set the Gateway Address using the machine's control panel.

You can protect the network setting using the machine's control panel. This menu helps you to prevent network setting being accidentally changed.

### Reference

For more information about using this machine as a network printer, see "Quick Configuration Guide" which is included as a PDF File on the CD-ROM labeled "Printer Drivers and Utilities". Read this manual as your first choice before referring to the paper version of the Quick configuration Guide which comes with optional Network Interface Board Type 450-E.

### 1 Press [User Tools/Counter].



TSP9040E

The following screen appears on the display panel.

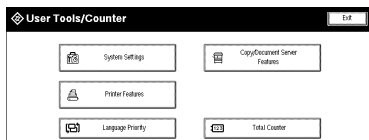

### 2 Press [Printer Features].

The following screen appears on the display panel.

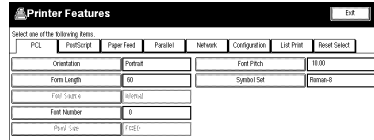

### 3 Press [Network].

The following screen appears on the display panel.

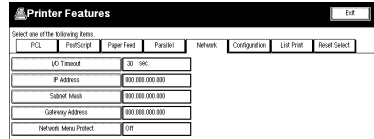

### 4 Press [IP Address].

The following screen appears on the display panel.

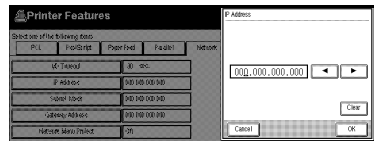

- 5 Set the IP Address with the number keys.

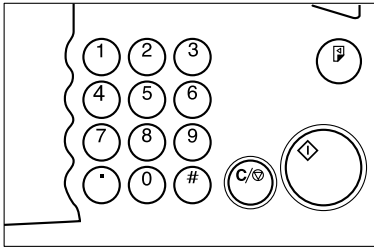

TSP5020E

**Note**

- ❑ To get the IP Address for the printer, contact your network administrator.
- ① Type the first three digits of the IP Address, and the pointer moves to the next entry field automatically. The following screen appears on the display panel.

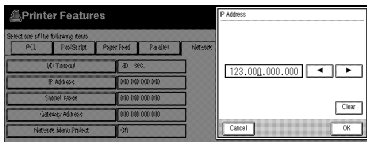

Repeat these procedures to complete setting the IP Address.

**Note**

- ❑ If you press "Clear", the numerical value currently entered is canceled.
  - ❑ If you press "Cancel", the entered value is canceled and the previous setting is restored.
- ② Press [OK]. The setting of the IP Address is completed. Then return to the "Printer Features" screen.

- 6 Set "Subnet Mask" and "Gateway Address" following the same procedure for setting the IP Address, if necessary.

## Protecting the Network Menu

You can protect the network setting to prevent it being accidentally changed.

- 1 Press [User Tools/Counter] on the control panel. The User Tools/Counter menu appears.
- 2 Press [Printer Features]. The Printer Features menu appears.
- 3 Press [Network]. The Network menu appears.
- 4 Press [Network Menu Protect].

The following screen appears on the display panel.

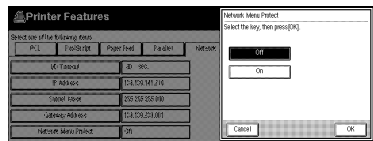

- ① When the key operator code has been set, enter the key operator code, up to 8 digits with the number keys, and then press [OK]. The following screen appears on the display panel.

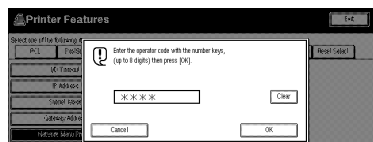

 **Reference**

For information about key operator code, see the “System Settings” manual.

**5** Select **[On]**. Then press **[OK]**.

Network Menu is protected.

 **Note**

- When “Network Menu Protect” is **[On]**, the icon will appear next to the menu name.

The following screen appears on the display panel.

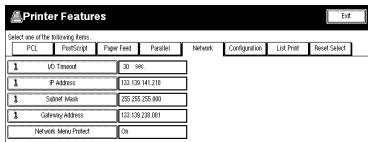

 **Reference**

For more information about network settings, see the “Quick Configuration Guide” which is provided as a PDF file on the CD-ROM labeled “Printer Drivers and Utilities”.

 **Address**

◆ **Subnet Mask**

A number used to mathematically “mask” or hide an IP Address on the network by eliminating those parts of the address that are alike for all the machines on the network.

◆ **Gateway Address**

A gateway is a connection or interchange point that connects two networks. A gateway address is for the router or host computer used as a gateway.

 **Note**

- To get the addresses, contact your network administrator.

2

# 3. Installing the Printer Driver and Software

This manual assumes that you are familiar with general Windows procedures and practices. If you are not, see the documentation that comes with Windows for details.

## Installation Method

The following table shows how to install the printer drivers and software.

	Auto Run <sup>*1</sup>		
	Quick Install		Custom installation <sup>*2</sup>
	Network connection with TCP/IP	Parallel connection	
PCL 6 printer driver	<input type="radio"/>	<input type="radio"/>	<input type="radio"/>
PCL 5e printer driver			<input type="radio"/>
PostScript 3 printer driver			<input type="radio"/>
Agfa Monotype Font Manager 2000			<input type="radio"/>
SmartNetMonitor for Admin			<input type="radio"/>
SmartNetMonitor for Client	<input type="radio"/>		<input type="radio"/>

<sup>\*1</sup> Available operating systems are as follows: Windows 95/98/Me, Windows 2000/XP, Windows NT 4.0

<sup>\*2</sup> Using custom installation, you can install various software separately.

### Reference

For more information about the printer drivers, see p.8 “Printer Drivers for This Machine”. For installing the printer drivers, see p.20 “Installing the PCL 6/5e Printer Driver” or p.22 “Installing the PostScript 3 Printer Driver”.

For more information about the software and utilities, see p.9 “Software and Utilities Included on the CD-ROM”.

### Important

- Before starting this installation, close all documents and applications. In a network environment, confirm that users who are logged on are disconnected. Be sure to do this when it will create the least interference with other users.
- After installing a printer driver, you must restart the computer.

### Note

- If the “plug and play” function is started, click **[Cancel]** in the **[New Hardware Found]**, **[Device Driver Wizard]** or **[Found New Hardware Wizard]** dialog box, and then insert the CD-ROM. The **[New Hardware Found]**, **[Device Driver Wizard]** or **[Found New Hardware Wizard]** dialog box appears depending on the system version of the Windows 95/98/Me, Windows 2000/XP.

## Quick Install

Auto Run starts the installer automatically when you load the CD-ROM in the CD-ROM drive. By selecting Quick Install, you can install the necessary software easily.

TCP/IP requires the following:

- This machine must be connected to the network through the network interface cable.
- This machine must be turned on.
- The TCP/IP protocol must be configured.
- An IP address must be allocated to this machine and to the computer.

### Limitation

- If your system is Windows 2000/XP or Windows NT 4.0, installing a printer driver by Auto Run requires Administrators permission. When you install a printer driver by Auto Run, log on using an account that has Administrators permission.

### Note

- Auto Run might not automatically work with certain OS settings. In this case, launch "Setup.exe" located on the CD-ROM root directory.

If you want to cancel Auto Run, hold down the **[Shift]** key (when your system is Windows 2000, hold down the left **[Shift]** key) while inserting the CD-ROM. Keep the **[Shift]** key held down until the computer has finished accessing the CD-ROM.

**1** Close all applications that are running.

**2** Insert the CD-ROM into the CD-ROM drive.

Auto Run will start the installer.

**3** Select a language to change the interface language, and then click **[OK]**.

The following languages are available: Cestina (Czech), Dansk (Danish), Deutsh (German), English (English), Espanol (Spanish), Francais (French), Italiano (Italian), Magyar (Hungarian), Nederlands (Dutch), Norsk (Norwegian), Polski (Polish), Portugues (Portuguese), Suomi (Finnish), Svenska (Swedish)

Default interface language is English.

**4** Select **[Quick Install]**.

**5** The software license agreement appears in the **[License Agreement]** dialog box.

After reading through all of the contents, click **[I accept the agreement.]** to agree with the License Agreement, and then click **[Next]**.

**6** Click to select a model name you want to use when the **[Select Printer]** dialog box appears.

 **Note**

- For a network connection with TCP/IP, select the machine whose IP address is displayed in **[Connect To]**.
- For parallel connection, select the machine whose printer port is displayed in **[Connect To]**.

**7** Click **[Install]**.

**8** Follow the instructions on the screen.

 **Note**

- During installation in Windows 2000, the **[Digital Signature Not Found]** dialog box may appear. In this case, click **[Yes]** to continue the installation.
- During installation in Windows XP, the **[Hardware Installation]** dialog box may appear. In this case, click **[Continue Anyway]** to continue the installation.

A message prompting you to restart your computer may appear. To complete the installation, restart your computer.

# Installing the PCL 6/5e Printer Driver

---

## Installing the PCL 6/5e Printer Driver

---

Two kinds of PCL printer drivers, PCL 6 and PCL 5e, are provided with this machine. We recommend PCL 6 as your first choice.

### Limitation

- If your system is Windows 2000/XP or Windows NT 4.0, installing a printer driver by Auto Run requires Administrators permission. When you install a printer driver by Auto Run, log on using an account that has Administrators permission.

### Important

- When updating the printer driver by installing the latest version, you should uninstall that of former version if any. See “Uninstalling the Printer Driver” in the “Printer Reference 2” manual.

**1** Close all applications that are running.

**2** Insert the CD-ROM into the CD-ROM drive.

Auto Run will start the installer.

**3** Select a language to change the interface language, and then click **[OK]**.

The following languages are available: Cestina (Czech), Dansk (Danish), Deutsch (German), English (English), Espanol (Spanish), Francais (French), Italiano (Italian), Magyar (Hungarian), Nederlands (Dutch), Norsk (Norwegian), Polski (Polish), Portugues (Portuguese), Suomi (Finnish), Svenska (Swedish)

Default interface language is English.

**4** Select **[PCL Printer Drivers]**.

**5** The software license agreement appears in the **[License Agreement]** dialog box.

After reading through all of the contents, click **[I accept the agreement]** to agree with the License Agreement, and then click **[Next]**.

**6** Select the printer driver you want to install when the **[Select Program]** dialog box appears.

**7** Follow the instructions on the screen.

### Note

- During installation in Windows 2000, the **[Digital Signature Not Found]** dialog box may appear. In this case, click **[Yes]** to continue the installation.
- During installation in Windows XP, the **[Hardware Installation]** dialog box may appear. In this case, click **[Continue Anyway]** to continue the installation.



## Setting up options

### Important

- If the machine is equipped with certain options (e.g. the Paper Feed Unit or the Memory Unit), you should set up the options with the printer driver.

### Limitation

- In Windows 2000/XP, changing the printer settings requires Manage Printers permission. Members of the Administrators and Power Users groups have Manage Printers permission by default. When you set up options, log on using an account that has Manage Printers permission.
- In Windows NT4.0, changing the setting of the printer requires Full Control access permission. Members of the Administrators, Server Operators, Print Operators, and Power Users groups have Full Control permission by default. When you set up options, log on using an account that has Full Control permission.

### Note

- When setting up options, you should access the **[Printer Properties]** dialog box from Windows. You cannot set up options by accessing the **[Printer Properties]** dialog box from an application.

### **1** Click **[Start]** on the taskbar, point to **[Settings]**, and then click **[Printers]**.

The **[Printers]** window appears.

### Note

- In Windows XP Professional, access the **[Printers and Faxes]** window from **[Start]** on the taskbar.
- In Windows XP Home Edition, access the **[Printers and Faxes]** window. Click **[Start]** on the taskbar, click **[Control Panel]**, **[Printers and Other Hardware]** and then **[Printers and Faxes]**.

### **2** Click to select the icon of the printer you want to use.

### **3** On the **[File]** menu, click **[Properties]**.

The **[Printer Properties]** dialog box appear.

### **4** Click the **[Accessories]** or **[Device Settings]** tab.

### **5** Select options you have installed from the **[Options]** or **[Installable Options]** group.

### **6** Click **[OK]**.

## Installing the PostScript 3 Printer Driver

This section describes basic instructions for installing the PostScript 3 printer driver. Actual procedures may vary depending on the operating system. Follow the appropriate procedures below.

### Reference

To use the PostScript 3 printer driver, the optional PostScript 3 Kit must be installed on the machine. See the “PostScript 3 Kit Type 700 Operating Instructions Supplement” manual for details.

### Important

- When updating the printer driver by installing the latest version, you should uninstall any earlier versions. See “Uninstalling the Printer Driver” in the “Printer Reference 2” manual.

---

## Windows 95/98/Me - Installing the PostScript 3 Printer Driver

---

### Installing the printer driver

---

**1** Close all applications that are running.

**2** Insert the CD-ROM into the CD-ROM drive.

Auto Run will start the installer.

**3** Select a language for the interface language, and then click [OK].

The following languages are available: Cestina (Czech), Dansk (Danish), Deutsch (German), English (English), Espanol (Spanish), Francais (French), Italiano (Italian), Magyar (Hungarian), Nederlands (Dutch), Norsk (Norwegian), Polski (Polish), Portugues (Portuguese), Suomi (Finnish), Svenska (Swedish)

Default interface language is English.

### Note

- The printer driver with the selected language will be installed.
- The printer driver will be installed in English if you select the following languages: Cestina, Magyar, Polski, Portugues and Suomi.

**4** Select [PostScript 3 Printer Driver].

[Add Printer Wizard] starts.

**5** Click [Next].

- 6** Check **[Local Printer]**, and then click **[Next]**.  
A dialog box for selecting the printer appears.
- 7** Select the model of the machine you are using, and then click **[Next]**.
- 8** In the **[Available ports:]** box, click **[Printer Port]**, and then click **[Next]**.
- 9** Change the name of the machine if you wish to, and then click **[Next]**.  
 **Note**  
 Check **[Yes]** if you want to set the machine as the default printer.
- 10** Follow the instructions on the screen.

---

### Setting up options

---

If the machine is equipped with certain options, you should set up the options using the printer driver.

- 1** Click **[Start]** on the taskbar, point to **[Settings]**, and then click **[Printers]**.  
The **[Printers]** window appears.
- 2** Click the icon of the machine you want to use.
- 3** On the **[File]** menu, click **[Properties]**.  
The **[Printer Properties]** dialog box appears.
- 4** Click the **[Accessories]** or **[Device Options]** tab.
- 5** Select the options you have installed from the **[Options]** or **[Installable Options]** group.
- 6** Click **[OK]**.

---

---

## Windows 2000/XP - Installing the PostScript 3 Printer Driver

---

---

### Installing the printer driver

---

#### Limitation

- Installing a printer driver requires Administrators permission. When you install a printer driver, log on using an account that has Administrators permission.

#### Note

- If you want to share the machine on a Windows 2000/XP platform, use the **[Sharing]** tab in the **[Printer Properties]** dialog box to specify the additional driver (alternate driver). For details, see the documentation that comes with Windows 2000/XP.
- When prompted for the additional driver (alternate driver) location, select the following folders on the CD-ROM:
  - **Windows 95/98/Me:** \DRIVERS\PS\WIN9X\_ME\ (Language)\DISK1\
  - **Windows NT 4.0:** \DRIVERS\PS\NT4\ (Language)\DISK1\

**1** Close all applications that are running.

**2** Insert the CD-ROM into the CD-ROM drive.

Auto Run will start the installer.

**3** Select a language for the interface language, and then click **[OK]**.

The following languages are available: Cestina (Czech), Dansk (Danish), Deutsch (German), English (English), Espanol (Spanish), Francais (French), Italiano (Italian), Magyar (Hungarian), Nederlands (Dutch), Norsk (Norwegian), Polski (Polish), Portugues (Portuguese), Suomi (Finnish), Svenska (Swedish)

Default interface language is English.

#### Note

- The printer driver with the selected language will be installed.
- The printer driver will be installed in English if you select the following languages: Cestina, Magyar, Polski, Portugues and Suomi.

**4** Select **[PostScript 3 Printer Driver]**.

**[Add Printer Wizard]** starts.

**5** Click **[Next]**.

**6** Check **[Local Printer]**, and then click **[Next]**.

A dialog box for selecting the printer port appears.

#### Note

- In Windows XP, check **[Local printer attached to this computer]**, and then click **[Next]**.

- 7** Select the check box of the port you want to use, and then click **[Next]**.

A dialog box for selecting the printer appears.

- 8** Select the model of the machine you are using, and then click **[Next]**.

- 9** Change the name of the machine if you wish to, and then click **[Next]**.

 **Note**

- Check **[Yes]** if you want to set up the machine as the default printer.

- 10** Select whether or not you want to share the machine, and then click **[Next]**.

 **Reference**

See the “Quick Configuration Guide” for information about setting up and using the machine in a network environment.

- 11** Follow the instructions on the screen.

 **Note**

- During installation, the **[Digital Signature Not Found]** dialog box may appear. In this case, click **[Yes]** to continue the installation.
- During installation in Windows XP, the **[Hardware Installation]** dialog box may appear. In this case, click **[Continue Anyway]** to continue the installation.

---

## Setting up options

---

If the machine is equipped with certain options, you should set up the options using the printer driver.

 **Limitation**

- Changing the printer settings requires Manage Printers permission. Members of the Administrators and Power Users groups have Manage Printers permission by default. When you set up options, log on using an account that has Manage Printers permission.

- 1** Click **[Start]** on the taskbar, point to **[Settings]**, and then click **[Printers]**.

The **[Printers]** window appears.

 **Note**

- In Windows XP Professional, access the **[Printers and Faxes]** window from **[Start]** on the taskbar.
- In Windows XP Home Edition, access the **[Printers and Faxes]** window. Click **[Start]** on the taskbar, click **[Control Panel]**, **[Printers and Other Hardware]** and then **[Printers and Faxes]**.

- 2** Click the icon of the machine you want to use.

**3** On the **[File]** menu, click **[Properties]**.

The **[Printer Properties]** dialog box appears.

**4** Click the **[Device Settings]** tab.

**5** Select the options you have installed from the **[Installable Options]** group.

**6** Click **[OK]**.

---

## Windows NT 4.0 - Installing the PostScript 3 Printer Driver

---

3

---

### Installing the printer driver

---

#### **Limitation**

- Installing a printer driver requires Administrators permission. When you install a printer driver, log on using an account that has Administrators permission.

#### **Important**

- The CD-ROM containing the Windows NT Server operating system version 4.0, or the Windows NT Workstation operating system is required for installing the printer driver.
- We recommend that you upgrade the Windows NT 4.0 operating system to Service Pack 6 or later before installing the printer driver. Contact your Windows retailer for more information about the latest version available.

#### **Note**

- If you want to share the machine on Windows NT 4.0, use the **[Sharing]** tab in the **[Printer Properties]** dialog box to specify the additional driver (alternate driver). For details, see the documentation that comes with Windows NT 4.0.
- When prompted for the additional driver (alternate driver) location, select the following folders on the CD-ROM:
  - **Windows 95/98/Me:** \DRIVERS\PS\WIN9X\_ME\ (Language)\DISK1\

**1** Close all applications that are running.

**2** Insert the CD-ROM into the CD-ROM drive.

Auto Run will start the installer.

**3** Select a language for the interface language, and then click **[OK]**.

The following languages are available: Cestina (Czech), Dansk (Danish), Deutsch (German), English (English), Espanol (Spanish), Francais (French), Italiano (Italian), Magyar (Hungarian), Nederlands (Dutch), Norsk (Norwegian), Polski (Polish), Portugues (Portuguese), Suomi (Finnish), Svenska (Swedish)

Default interface language is English.

 **Note**

- The printer driver with the selected language will be installed.
- The printer driver will be installed in English if you select the following languages: Cestina, Magyar, Polski, Portugues and Suomi.

**4** Select **[PostScript 3 Printer Driver]**.

**[Add Printer Wizard]** starts.

**5** After confirming that the **[My Computer]** option is selected, click **[Next]**.

A dialog box for selecting the printer port appears.

**6** Select the check box of the port you want to use, and then click **[Next]**.

A dialog box for selecting the printer appears.

**7** Select the model of the machine you are using, and then click **[Next]**.

**8** Change the name of the machine if you wish to, and then click **[Next]**.

 **Note**

- Check **[Yes]** if you want to set up the machine as the default printer.

**9** Select whether or not you want to share the machine, and then click **[Next]**.

 **Reference**

See the “Quick Configuration Guide” for information about setting up and using the machine in a network environment.

**10** Follow the instructions on the screen.

---

## Setting up options

---

If the machine is equipped with certain options, you should set up the options using the printer driver.

 **Limitation**

- Changing the printer settings requires Manage Printers permission. Members of the Administrators and Power Users groups have Manage Printers permission by default. When you set up options, log on using an account that has Manage Printers permission.

**1** Click **[Start]** on the taskbar, point to **[Settings]**, and then click **[Printers]**.

The **[Printers]** window appears.

**2** Click the icon of the machine you want to use.

**3** On the [File] menu, click [Properties].

The [Printer Properties] dialog box appears.

**4** Click the [Device Settings] tab.

**5** Select the options you have installed from the [Installable Options] group.

**6** Click [OK].

---

## Mac OS - Installing the PostScript 3 Printer Driver and Utilities

---

It is necessary to install a printer driver and a PPD file to print from a Macintosh. Follow the procedures to install a printer driver and a PPD file on Macintosh running OS 8.6 or later versions up to 9.2, and Mac OS X Classic mode.

 **Note**

For installing the PostScript 3 printer driver in Mac OS X, see p.30 “Mac OS X - Installing the PostScript 3 Printer Driver”

**1** Insert the CD-ROM into the CD-ROM drive.

**2** Double-click the CD-ROM icon.

**3** Double-click the [Mac OS 8 and 9] folder.

**4** Double-click the [PS Driver] folder.

**5** Double-click the folder of the language you use.

**6** Open [Disk 1] and double-click the installer icon.

The PostScript 3 printer driver installer window appears.

**7** Follow the instructions on the screen.

**8** Double-click [Extensions] in [System Folder].

**9** Double-click [Printer Descriptions].

**10** Double-click the CD-ROM icon on the desktop.

**11** Double-click the [Printer Descriptions] folder in the [Mac OS 8 and 9] folder.

**12** Double-click [Disk 1] in the folder of the language you use.

**13** Drag the PPD file into [Printer Descriptions] in [Extensions] in [System Folder].

**14** Drag the plugin file into [Printer Descriptions] in [Extensions] in [System Folder].

**15** Restart the Macintosh.



---

## Setting Up the PPD File

---

### Preparation

Confirm that the machine is connected to an AppleTalk network before performing the following procedure.

- 1** On the Apple menu, select **[Chooser]**.
- 2** Click the **[Adobe PS]** icon.
- 3** In the **[Select a PostScript Printer:]** list, click the name of the machine you want to use.
- 4** Click **[Setup]**.
- 5** Click the printer description file you want to use, and then click **[Select]**.

The PPD file is set up, and the **[Adobe PS]** icon appears at the left of the machine name in the list. Next, follow the procedure on p.29 “Setting up options” to make the option settings, or close the **[Chooser]** dialog box.

---

## Setting up options

---

- 1** On the Apple menu, select **[Chooser]**.
- 2** Click the **[Adobe PS]** icon.
- 3** In the **[Select the PostScript Printer:]** list, click the name of the machine you want to use, and then click **[Setup]**.
- 4** Click **[Configure]**.  
A list of options appears.
- 5** Select the options you want to set up and select the appropriate setting for it.

### Note

- If the option you want to set up does not appear, the PPD file has not been set up correctly. Check the name of the PPD file shown in the dialog box.

- 6** Click **[OK]**.  
A list of options closes.
- 7** Click **[OK]**.  
The **[Chooser]** dialog box appears.
- 8** Close the **[Chooser]** dialog box.

---

## Mac OS X - Installing the PostScript 3 Printer Driver

---

It is necessary to install a PPD file to print from a Macintosh. Follow the procedures to install a PPD file on Macintosh running Mac OS X.

### Preparation

You need an administrator name and a password (phrase). For more information, consult your administrator.

- 1** Insert the CD-ROM into the CD-ROM drive.
- 2** Double-click the CD-ROM icon.
- 3** Double-click the [Mac OS X] folder.
- 4** Double-click the installer icon.
- 5** Follow the instructions on screen.

---

### Setting Up the PPD File

---

- 1** Run Print Center.
- 2** Click [Add Printer].

#### Note

- Select [AppleTalk] in the first pop-up menu.
- If the zone has been set, select the zone in the second pop-up menu.

- 3** Select the PPD file for the model you are using from the “Printer Model:” pop-up menu.
- 4** Click [Add].

---

### Setting Up Options

---

#### Limitation

- You cannot make printer option settings in Mac OS X. Do not make settings for options that have not been installed.

# Installing the SmartNetMonitor for Client / Admin

## 📍 Limitation

- ❑ If your operating system is Windows 2000/XP or Windows NT 4.0, installing software by Auto Run requires Administrators permission. When you install a printer driver by Auto Run, log on using an account that has Administrators permission.

**1** Close all applications that are running.

**2** Insert the CD-ROM into the CD-ROM drive.

Auto Run will start the installer.

**3** Select a language to change the interface language, and then click **[OK]**.

The following languages are available: Cestina (Czech), Dansk (Danish), Deutsch (German), English (English), Espanol (Spanish), Francais (French), Italiano (Italian), Magyar (Hungarian), Nederlands (Dutch), Norsk (Norwegian), Polski (Polish), Portugues (Portuguese), Suomi (Finnish), Svenska (Swedish)

Default interface language is English.

**4** Select **[SNM-C-A]**.

The software license agreement appears in the **[License Agreement]** dialog box.

**5** After reading through all of the contents, click **[I accept the agreement]** to agree with the license agreement, and then click **[Next]**.

**6** Select the program you want to install when the **[Select Program]** dialog box appears.

**7** Follow the instructions on the screen.

# Installing the Agfa Monotype Font Manager 2000

## ⚠ Limitation

- ❑ If your operating system is Windows 2000/XP or Windows NT 4.0, installing software by Auto Run requires Administrators permission. When you install a printer driver by Auto Run, log on using an account that has Administrators permission.

3

**1** Close all applications that are running.

**2** Insert the CD-ROM into the CD-ROM drive.

Auto Run will start the installer.

**3** Select a language to change the interface language, and then click [OK].

The following languages are available: Cestina (Czech), Dansk (Danish), Deutsch (German), English (English), Espanol (Spanish), Francais (French), Italiano (Italian), Magyar (Hungarian), Nederlands (Dutch), Norsk (Norwegian), Polski (Polish), Portugues (Portuguese), Suomi (Finnish), Svenska (Swedish)

Default interface language is English.

**4** Select [Agfa Monotype Font Manager 2000].

**5** Follow the instructions on the screen.

# Using Adobe PageMaker Version 6.0, 6.5 or 7.0

If you use the machine under Windows 95/98/Me, Windows 2000/XP or Windows NT 4.0 with Adobe PageMaker, you need to copy the PPD file to the PageMaker folder.

The PPD file is the file with extension “.ppd”. It is in the folder “DRIVERS\PS\WIN9X\_ME\ (Language)\DISK1\” on the CD-ROM.

The “WIN9X\_ME” folder, inside the “PS” folder is for Windows 95/98/Me. Use the folder at this level that is appropriate for the operating system you are currently using.

The third folder, “(Language)” may be substituted by an appropriate language name.

Copy the file with extension “.ppd” to the PageMaker folder.

- **For PageMaker 6.0 default installation**  
The directory is “C:\PM6\RSRC\PPD4”.
- **For PageMaker 6.5 default installation**  
The directory is “C:\PM65\RSRC\USENGLISH\PPD4”.  
The “USENGLISH” may vary depending on your language selection.
- **For PageMaker 7.0 default installation**  
The directory is “C:\PM7\RSRC\USENGLISH\PPD4”.  
The “USENGLISH” may vary depending on your language selection.

# INDEX

---

10BASE-T/100BASE-TX, 3

## A

---

Agfa Monotype Font Manager 2000  
*installing*, 32

## C

---

Clear Modes/Energy Saver key, 10  
Control Panel, 10

## D

---

Display Panel, 11  
Display panel, 10

## F

---

Function Status indicators, 10

## G

---

Gateway Address, 15

## M

---

Mac OS  
*PostScript 3, installing*, 28  
Mac OS X  
*PostScript 3, installing*, 30  
↔Data In indicator, 10

## N

---

Network Connections, 4  
Network Interface Board 450, 5  
Number keys, 11

## O

---

Online and Offline, 11  
Operation switch, 10

## P

---

PageMaker 6.0, 6.5 or 7.0, 33  
Parallel Cable, 4, 6  
Parallel Port, 3  
PCL 5e, 8  
*Setting up options*, 21  
*Windows, installing*, 20  
PCL 6, 8  
*Setting up options*, 21  
*Windows, installing*, 20  
PostScript 3  
*Mac OS, installing*, 28  
*Mac OS X, installing*, 30  
*Windows 2000/XP, installing*, 24  
*Windows 95/98/Me, installing*, 22  
*Windows NT 4.0, installing*, 26  
Printer Driver  
*Install*, 17  
printer driver, 8

## Q

---

Quick Install  
*Printer driver and Software*, 18

## S

---

SmartNetMonitor for Admin, 31  
SmartNetMonitor for Client, 31  
Software  
*Install*, 17  
Subnet Mask, 15

## U

---

User Tools/Counter key, 10

## W

---

Windows 2000/XP  
*PostScript 3, installing*, 24  
Windows 95/98/Me  
*PostScript 3, installing*, 22  
Windows NT 4.0  
*PostScript 3, installing*, 26



Declaration of Conformity

"The Product complies with the requirements of the EMC Directive 89/336/EEC and the Low Voltage Directive 73/23/EEC."



**Caution:**

Properly shielded and grounded cables (STP) and connectors must be used for connections to host computer (and/or peripheral) in order to meet EMC Directive 89/336/EEC emission limits.



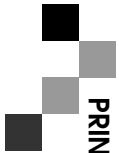

**PRINTER Controller Type 1055 OPERATING INSTRUCTIONS PRINTER REFERENCE 1 (option)**